

# IO FiX

IntraOsseous Fixation

MCP

## Surgical Technique



- Stable intramedullary fixation
- Fixed 25° angle for reproducible results
- Implant compresses across joint
- Superior bending resistance minimizing implant cut out
- Avoid hardware complications from tissue irritation caused by plates and wires
- Advanced instrumentation reduces procedure time
- Avoids the need to bend plates or hardware
- Removable

Patent Pending

*As described by Brian D. Adams, M.D., Iowa City, IA, O. Alton Barron, M.D., New York, NY  
 and John Faillace, M.D., Waco, TX*  
**CAUTION: Federal Law (USA) restricts this device to sale by or on the order of a physician.**

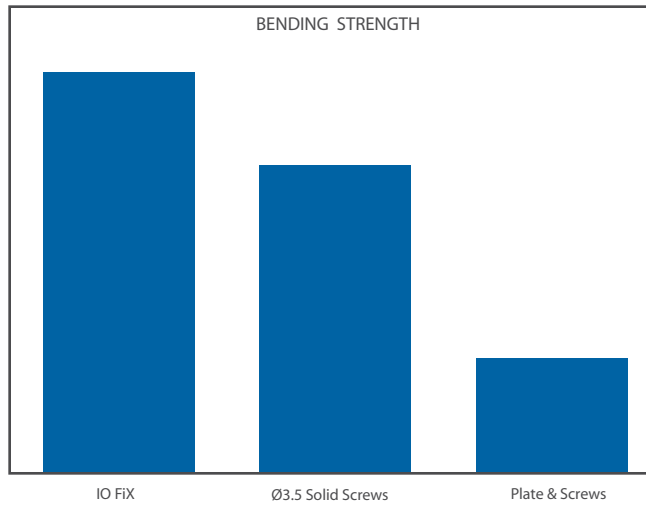

**1.5X stronger than multiple screw construct**  
**3.5X stronger than dorsal plate constructs**

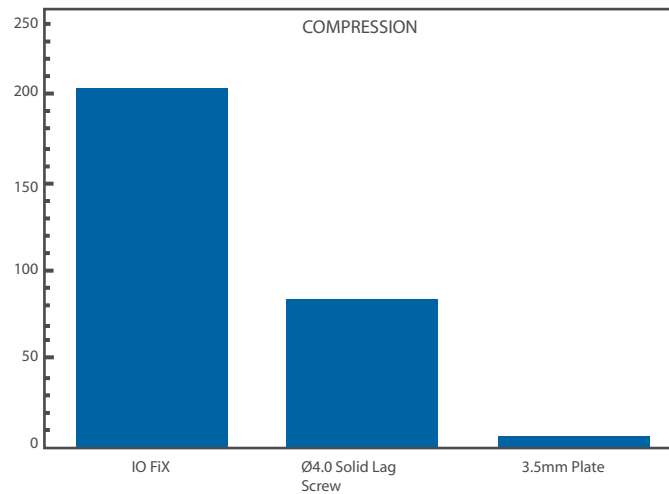

**2.5X more delivered compression than Ø4.0 screw construct**  
**45X more delivered compression than plate and screw construct**

**INDICATIONS FOR USE**

The Extremity Medical IO FiX MCP System is intended for arthrodesis fixation of the metacarpal-phalangeal joints.

**STEP 1 - Exposure**

A dorsal longitudinal incision is made over the metacarpal-phalangeal joint. The metacarpal-phalangeal joint is exposed by mobilizing the extensor tendon mechanism. The joint is fully flexed to visualize the metacarpal head and proximal phalanx base.

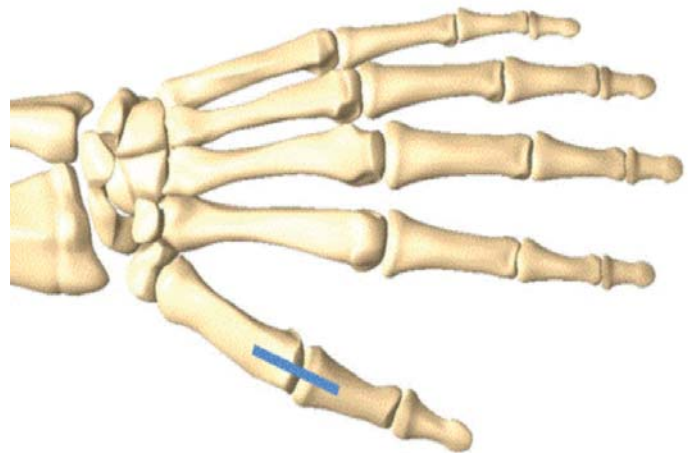

**STEP 2 - Metacarpal Preparation**

Insert a 1.6mm guidewire into the center of the metacarpal medullary canal and confirm its position using fluoroscopy. Place the cannulated metacarpal reamer over the wire and insert until the black depth line is just beneath the articular surface.

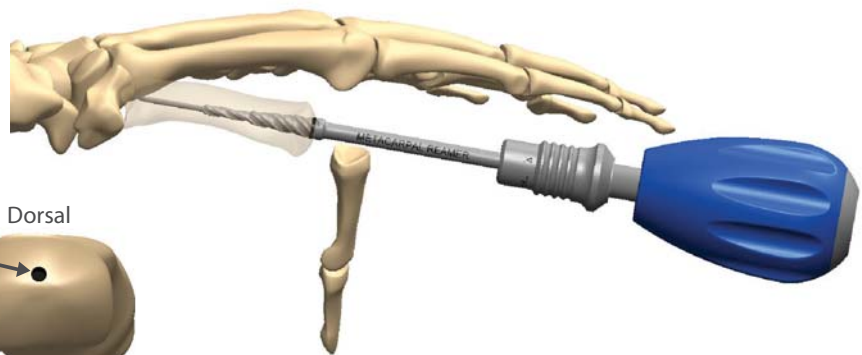
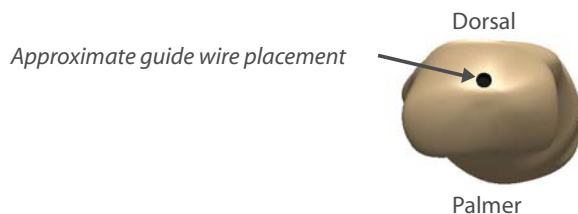
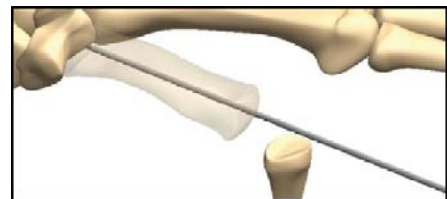

### STEP 3 - Metacarpal Implant Alignment

Pre-operative X-ray templating is used to select the proper metacarpal implant size. Align the indicator on the metacarpal implant with the indicator on the Driver. Insert the metacarpal implant until it is recessed below the articular surface by 1-2 mm and the indicator is positioned dorsally at the apex of the desired angle of fusion as shown in the figure at right.

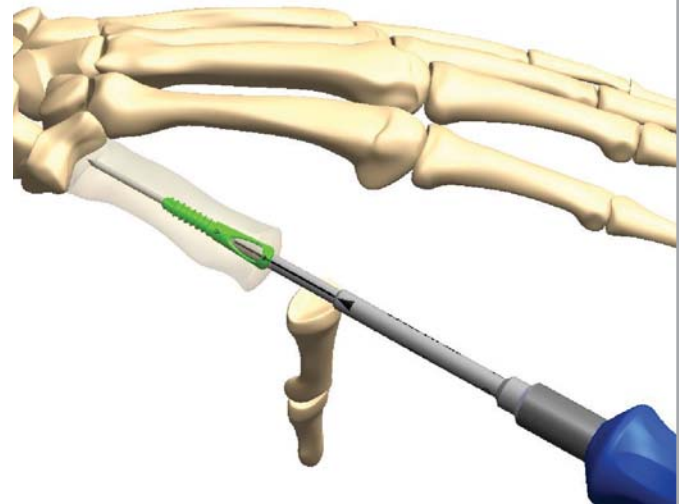

### STEP 4 - Dorsal Window and Metacarpal Joint Preparation

The distal surface of the metacarpal implant has a built-in 25° angle. Insert the Dorsal Window Rasp into the metacarpal implant and advance the rasp with a rotating motion until a dorsal window is created in the metacarpal and the metacarpal head is flattened. The Dorsal Window Rasp has a positive stop designed to leave the implant 1mm recessed while creating a 25° angled surface. Remove any remaining bone around the resected surface.

*Laser line aids in alignment of Dorsal Window Rasp.*

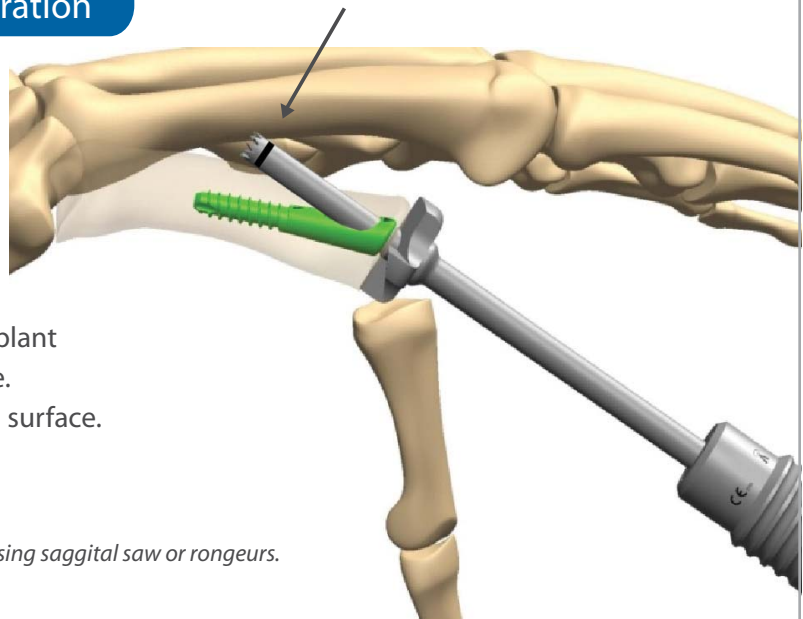

*\* Do not use power.*

*\* Remove peripheral ring or any impinging bone to seat flush using sagittal saw or rongeurs.*

### STEP 5 – Dorsal Window Reaming

Insert the Dorsal Window Reamer into the dorsal window of the metacarpal implant and gently rotate to widen the dorsal bony window for the lag screw head.

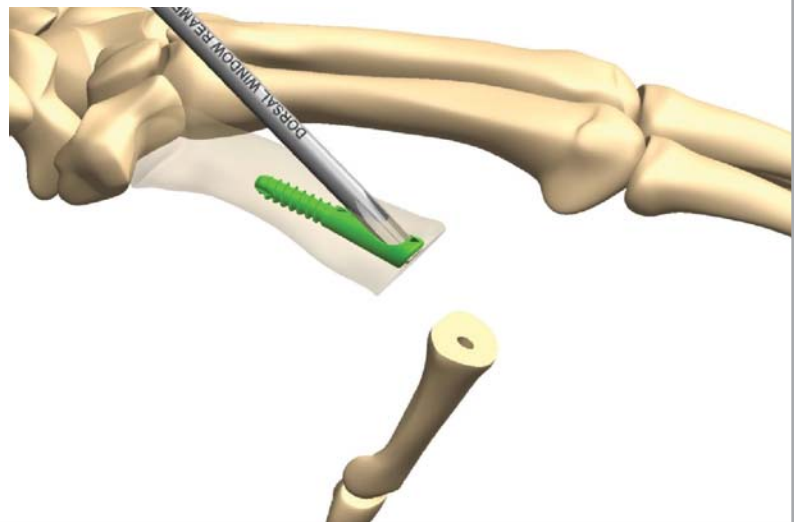

### STEP 6 – Phalanx Guidewire Placement and Joint Preparation

Insert a 1.6mm guidewire positioned one third dorsal on the proximal phalanx to the desired lag screw depth and confirm its position using fluoroscopy. Select the appropriate size Lag Screw Rasp. Advance the rasp over the guidewire with a rotating motion to create a flattened surface. Remove the rasp but leave the guidewire in place.

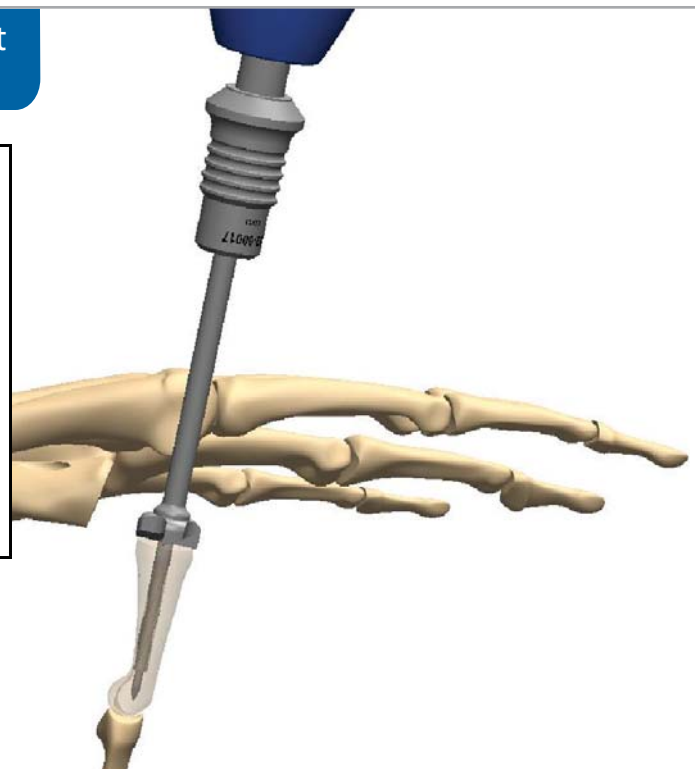
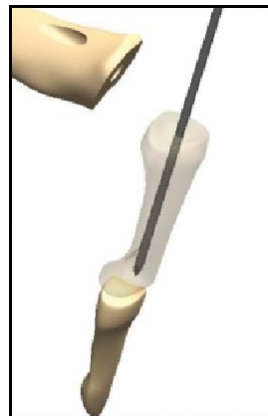

\* Lag screw rasp has a Ø3.0mm x 20mm drill for the lag screw. If it is necessary to drill deeper than 20mm, use the supplied Ø3.0mm drill.

\* Remove peripheral ring or any impinging bone to seat flush using sagittal saw or rongeurs.

## STEP 7 - Lag Screw Depth Measurement

Advance the Depth Gauge over the guidewire until the tip makes contact with the base of the phalanx.

*Note: Due to amount of compression it is recommended to select a shorter length lag screw.*

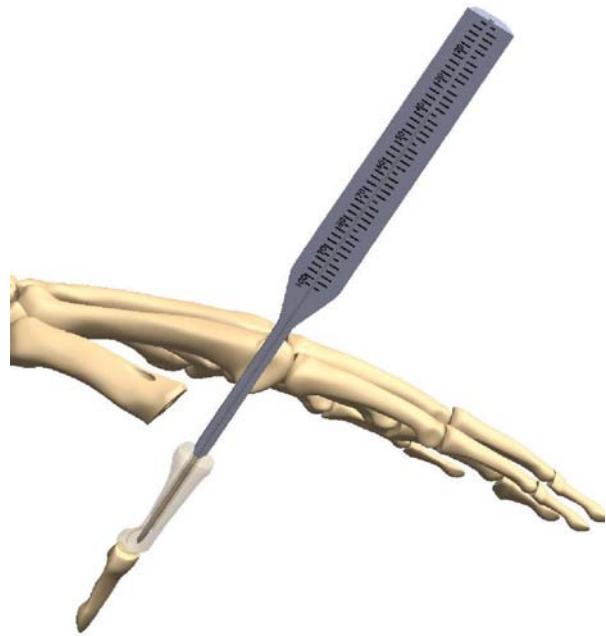

## STEP 8 - Lag Screw and Phalanx Alignment

Insert the proper size lag screw through the dorsal window of the metacarpal implant. Position the tip of the lag screw into the pilot hole previously created in the phalanx. While firmly holding the phalanx, advance the lag screw into the phalanx until increased torque is felt which signals engagement and locking of the Morse Taper between the lag screw and metacarpal implant. *Avoid over tightening and over stressing the bone screw interface.*

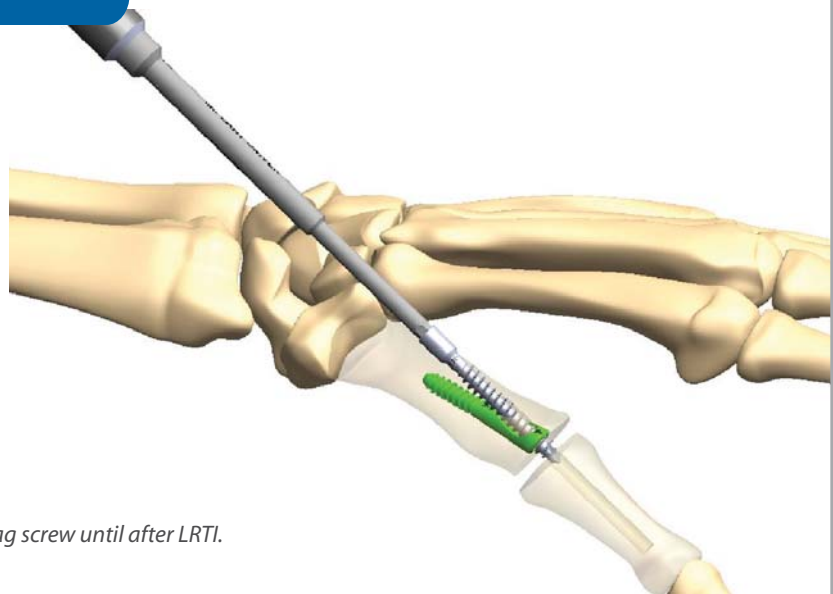

*\* Prep Metatarsal & Phalanx prior to LRTI, but do not insert lag screw until after LRTI.*

## STEP 9 – Closure

Verify under fluoroscopy that the lag screw is fully seated. The extensor mechanism is repaired and the skin closed in standard fashion.

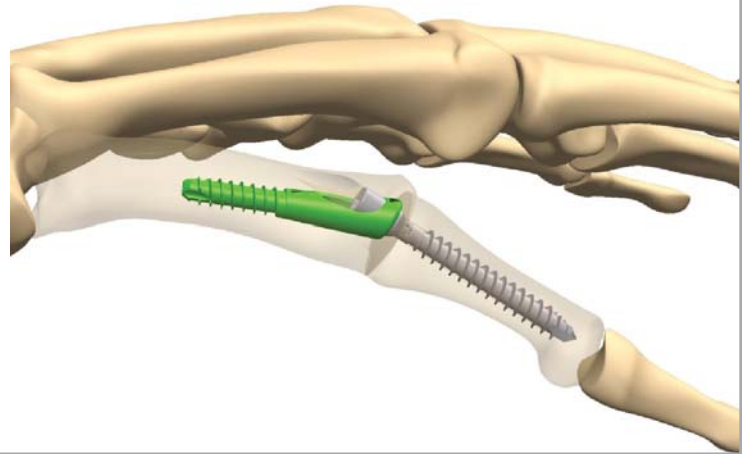

## POSTOPERATIVE TREATMENT

A cast or splint is used to protect and support the thumb during healing and only limited load bearing is allowed until the fusion is complete.

## Screw Removal

Remove tissue in-growth from the dorsal metacarpal window and lag screw head hex recess. Insert the Removal Driver and Removal Tool to the lag screw. Unscrew the lag screw counterclockwise a half turn. In the event the locking mechanism is still engaged, attach the Slap Hammer and apply slight pressure to disengage the Morse Taper. Continue turning the Screw Driver counterclockwise until the entire lag screw is removed. The metacarpal implant can be removed by exposing the metacarpal-phalangeal joint and clearing all tissue in-growth in the hex recess. Attach the Implant Driver and turn counterclockwise to remove the implant.

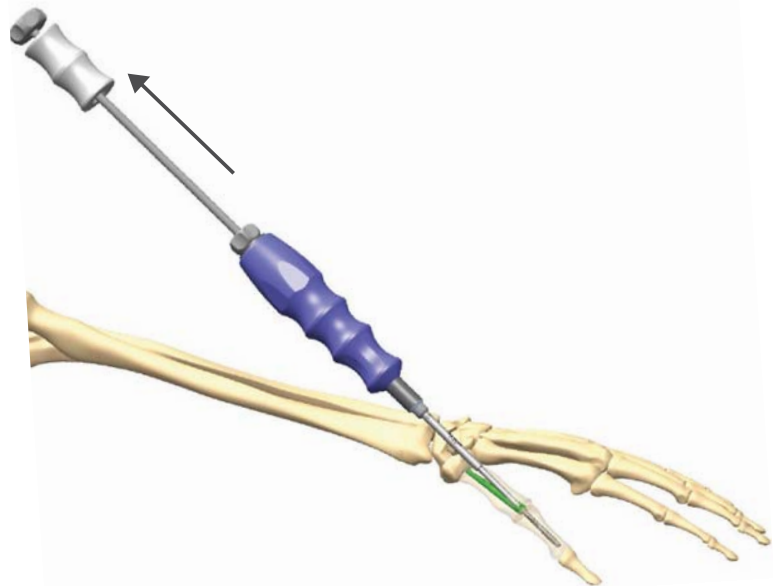

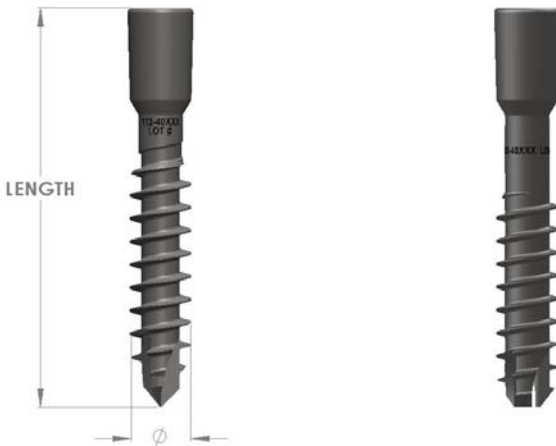

**LAG SCREWS**

Catalog#	Description	QTY
102-40020	Small Lag Screw - 4.0mm x 20 mm	1
102-40022	Small Lag Screw - 4.0mm x 22 mm	1
102-40024	Small Lag Screw - 4.0mm x 24 mm	1
102-40026	Small Lag Screw - 4.0mm x 26 mm	1
102-40028	Small Lag Screw - 4.0mm x 28 mm	1
102-40030	Small Lag Screw - 4.0mm x 30 mm	1
102-40032	Small Lag Screw - 4.0mm x 32 mm	1
102-40034	Small Lag Screw - 4.0mm X 34mm	1
102-40036	Small Lag Screw - 4.0mm x 36 mm	1
113-40020	Small Lag Screw (Solid) 4.0mm x 20 mm	1
113-40022	Small Lag Screw (Solid) 4.0mm x 22 mm	1
113-40024	Small Lag Screw (Solid) 4.0mm x 24 mm	1
113-40026	Small Lag Screw (Solid) 4.0mm x 26 mm	1
113-40028	Small Lag Screw (Solid) 4.0mm x 28 mm	1
113-40030	Small Lag Screw (Solid) 4.0mm x 30 mm	1
113-40032	Small Lag Screw (Solid) 4.0mm x 32 mm	1
113-40034	Small Lag Screw (Solid) 4.0mm x 34 mm	1
113-40036	Small Lag Screw (Solid) 4.0mm x 36 mm	1

**METACARPAL IMPLANTS**

Catalog#	Description	QTY
120-12530	Small Metacarpal Implant – 4.0mm x 30mm	2
120-22530	Medium Metacarpal Implant – 5.0mm x 30mm	2
120-32530	Large Metacarpal Implant – 6.0mm x 30mm	2

*\*All Metacarpal Implants have built in 25° of dorsiflexion*

**DISPOSABLE INSTRUMENTS**

Catalog #	Description	QTY
102-00023	Double-Ended Guidewire - 1.6 mm	5
102-00002	Cannulated Drill - 3.0 mm	2
120-01000	Metacarpal Reamer	2
101-00023	Cleaning Brush - 1.6mm	2
120-00002	MCP X-Ray Template	1
120-02012	12mm Dorsal Window Rasp	1
120-02016	16mm Dorsal Window Rasp	1
120-04012	12mm Lag Screw Rasp	1
120-04016	16mm Lag Screw Rasp	1

**REUSABLE INSTRUMENTS**

Catalog#	Description	QTY
120-00000	IO FiX MCP Instrument Tray	1
120-00001	IO FiX MCP Implant Caddy	1
101-00009	Guidewire Holder 1.6mm	1
113-00003	Depth Gauge	1
120-03000	Dorsal Window Reamer	1
102-00009	3.0 Screw Driver	1
102-00017	AO Quick Connect Handle	1
102-00020	Removal Screw Driver	1
102-00021	Removal Tool	1
102-00022	Slap Hammer	1

